Service Manual
for MDA2

HTC Proprietary
Confidential Treatment Requested

Rev. 1.0
September 12, 2003

HTC Corp.
Engineering Mobility

TITLE: Service Manual for MDA2

REV. NO.	DATE	CONTENTS	DEP.	REVISED	APP'D	STGE.PER.
1.0	Aug 26,2003		TSD			

Table of contents

1. INTRODUCTION	4
2. PRODUCT SPECIFICATIONS	4
2.1 PRODUCT CONFIGURATION	4
2.2 SPECIFICATIONS OF MDA2	5
2.3 SPECIFICATIONS OF AC ADAPTER	5
2.4 GSM/GPRS FUNCTIONAL BLOCK PART	5
3. SYSTEM BLOCK DIAGRAM	10
4. SERVICING TOOLS	11
5. ASSEMBLING AND DISASSEMBLING	12
5.1 DISASSEMBLING	12
5.2 ASSEMBLING	19
6. PROBLEM DIAGNOSTICS	26
6.1 LIST OF TEST JIGS	26
6.2 CLASSIFICATION OF NON CONFORMITY	27
6.3 TROUBLESHOOTING AND REPAIR	28
7. DIAGNOSTIC PROGRAMS	34
7.1 LIST OF TEST ITEMS	34
7.2 TEST ITEMS OPERATION	34
8. SPARE PARTS LIST & EXPLODED DIAGRAMS	38
8.1 Exploded Diagrams	38
8.2 LIST OF SPEAR PARTS	39
<u>APPENDIX</u>	40
A. CUSTOMER, RETAILER MISJUDGMENT	40
B. REPAIR TROUBLE SHOOTING GUIDE	41

1.Introduction

This manual provides the technical information to support the service activities of the MDA2.

This document contains highly confidential information, so any or all of this document should not be revealed to any third party.

2.Product Specifications

2.1 Product Configuration

Standard Package

Item	Contain
1	Main Unit
2	USB Cradle
3	Stylus
4	AC Adapter
5	Earphone
6	Pouch, Leather Case
7	Service Kit
8	Quick Start Guide
9	User's Manual
10	Battery Pack

2.2 Specifications of MDA2

Item	Specification
Platform	<ul style="list-style-type: none"> ● Microsoft Pocket PC 2003 phone edition - English, French, German, Italian, Spanish, Portuguese. ● Combined GSM/GPRS and PDA. ● 2 logical block (PDA and GSM/GPRS) solution, layout is integrated into one module ● GSM/GPRS can be turned off to let PDA to run alone
Outside Dimensions	● 69.9mm(W) x 130mm(H) x 19mm (T)
Weight	● Less than 200g
Battery	<ul style="list-style-type: none"> ● Removable rechargeable Lithium Polymer battery ● 1200 mAh(Typical) ● Data retention time : 72 hrs ● Separated Back up battery(25 mAh,rechargeable), data retention time above 0.5 hrs ● Battery Life : 15 hrs of PDA ● Talk time : 2.5 ~ 4 hrs ● Standby : 180 hrs
2.3 Specification of AC ADAPTER	
AC Adapter	<ul style="list-style-type: none"> ● AC input 100 ~ 240 Vac, 50/60 HZ ● AC input current : 0.2 A max ● Output voltage : 5V dc ● Output current : 2A (typical)
2.4 GSM/GPRS Functional Block	

GPRS/GSM (Tri-band) module Antenna Generic GSM Service	<ul style="list-style-type: none"> ● GSM900: 880-915, 925-960MHz ● DCS1800 1710 ~ 1785, 1805 ~ 1880 MHz ● PCS1900 1850 ~ 1910, 1930 ~ 1990MHz <ul style="list-style-type: none"> ● Internal Antenna ● Call forwarding ● Explicit Call Transfer ● Spool Icon ● Wave ring tone download /compose ● Long message (640 characters) ● SIM LOCK ● Network lock
GPRS functionality	<ul style="list-style-type: none"> ● GPRS Class B, ● Multi-slot Class 10
Memory ROM RAM	<ul style="list-style-type: none"> ● 32MB(Standard,CPU embedded) and 64/96/160MB (CPU embedded 32MB NOR Flash,32 bit Data bus + M-System 32/64/128 MB NAND Flash,16 bit data bus) ● 64MB(Standard model)SDRAM, and 128MB(enhanced model)
SIM	<ul style="list-style-type: none"> ● 3V SIM Operation
PDA Functional Block	
Processor	TI Calypso + IOTA, GSM/GPRS solution Intel PXA263 CPU (Low power, High Performance,32 bit
Clock Speed	400MHz
LCD Module	Transflective TFT-LCD with back light LEDs, 240 x 320 x 64K Sensitive Touch Screen
Graphic Controller	MPEG4 decoder 2D Graphic accelerator

Interface	<ul style="list-style-type: none"> ● One Infrared port IrDA SIR ● One 22 pin individual Port for signals (for USB, Serial, Car Kit, Power and Audio) ● One SIM card slot ● One SDIO/MMC card slot (B-Square SDIO driver) ● One 34 pin Back pack connector ● One Audio Jack (2.5)
Stylus	<ul style="list-style-type: none"> ● Lock type mechanism
Keyboard/Button/Switch	<ul style="list-style-type: none"> ● One five way navigation button ● One Power button(wake-up key) ● One volume control button(up & down) ● Two phone button, SEND(Yes) & END(No) (Wake-up keys),with LED backlight ● Two programmable AP buttons(Wake up key) ● Camera (Side button) Press to launch camera capture utility, and take picture for 2nd press ● Voice command/Voice recorder (side button) <ul style="list-style-type: none"> ➤ Press for voice command ➤ Press and hold for Voice recorder ● Reset Switch ● Key lock function support by software
Notification	<ul style="list-style-type: none"> ● One Bi-color LED for GSM standby, GSM message, GSM network status, PDA notification, PDA Charging status. ● One Blue LED for Bluetooth system notification of powered –ON and ready to transmit RF signal. ● Notification by sound, Message, Vibration on the display.

Audio	<ul style="list-style-type: none"> ● Microphone build in ● Software Echo cancellation ● Receiver ● Hardware AGC ● Hardware Full duplex ● WAV/WMA/MP3 stereo ● 16 bits with 8KHz,11 KHz,16KHz,22KHz,44.1 KHz, 48 KHz sampling rate
CMOS Camera	<ul style="list-style-type: none"> ● Color CMOS camera module ● VGA (480x640) resolution with JPEG encoder ● ALC (Auto Light Control) ● AWB (Auto White Balance) ● Preview Mirror on battery cover ● Camcorder QCIF, 15 fps(min), (in live mode)(max 15 seconds per clip) ● Operating in 5 Lux(Min)
Cradle	<ul style="list-style-type: none"> ● Cradle connector connected to main unit ● Audio jack (2.5) ● Microphone ● 2 slots, one for main unit + battery, another is capable of charging 2nd battery ● Serial or USB cable between cradle and PC ● LED indicator for 2nd battery charging
Bluetooth	<ul style="list-style-type: none"> ● Bluetooth 1.1 compliant ● Power class 2 ● Support Profile <ul style="list-style-type: none"> ➤ Generic access ➤ Generic object Exchange

<p>Accessories</p>	<ul style="list-style-type: none"> ● Retractable sync. Cable (USB/Serial) ● Cradle (USB, Serial) ● AC adapter ● Car adapter ● Stylus ● AC adapter with power plug ● Detacheable LCD protector ● Car Kit ● Stereo wired headset with mono microphone, volume control, Pick up/Hang up the incoming/Outgoing call, Call waiting, conference call, microphone mute. ● Mono Wired headset ● Stereo Bluetooth headset ● Option Battery (1200 mAh) ● Keyboard ● TTY Adaptor (Stereo > Mono in audio jack) ● Remote controller for VGA output ● Back pack : CF + TV/VGA out (within cable) + 600 mAh battery <p>CF Slot support</p> <ul style="list-style-type: none"> ➤ Wireless LAN ➤ GPS CF card ➤ Micro drive ➤ CDMA CF Card ➤ I/O card (Barcode reader,etc)
<p>Regulatory</p>	<ul style="list-style-type: none"> ● PTCRB (For North America Market) ● R&TTE ● FCC ● USB V1.1 Compliance test

3.SYSTEM BLOCK DIAGRAM

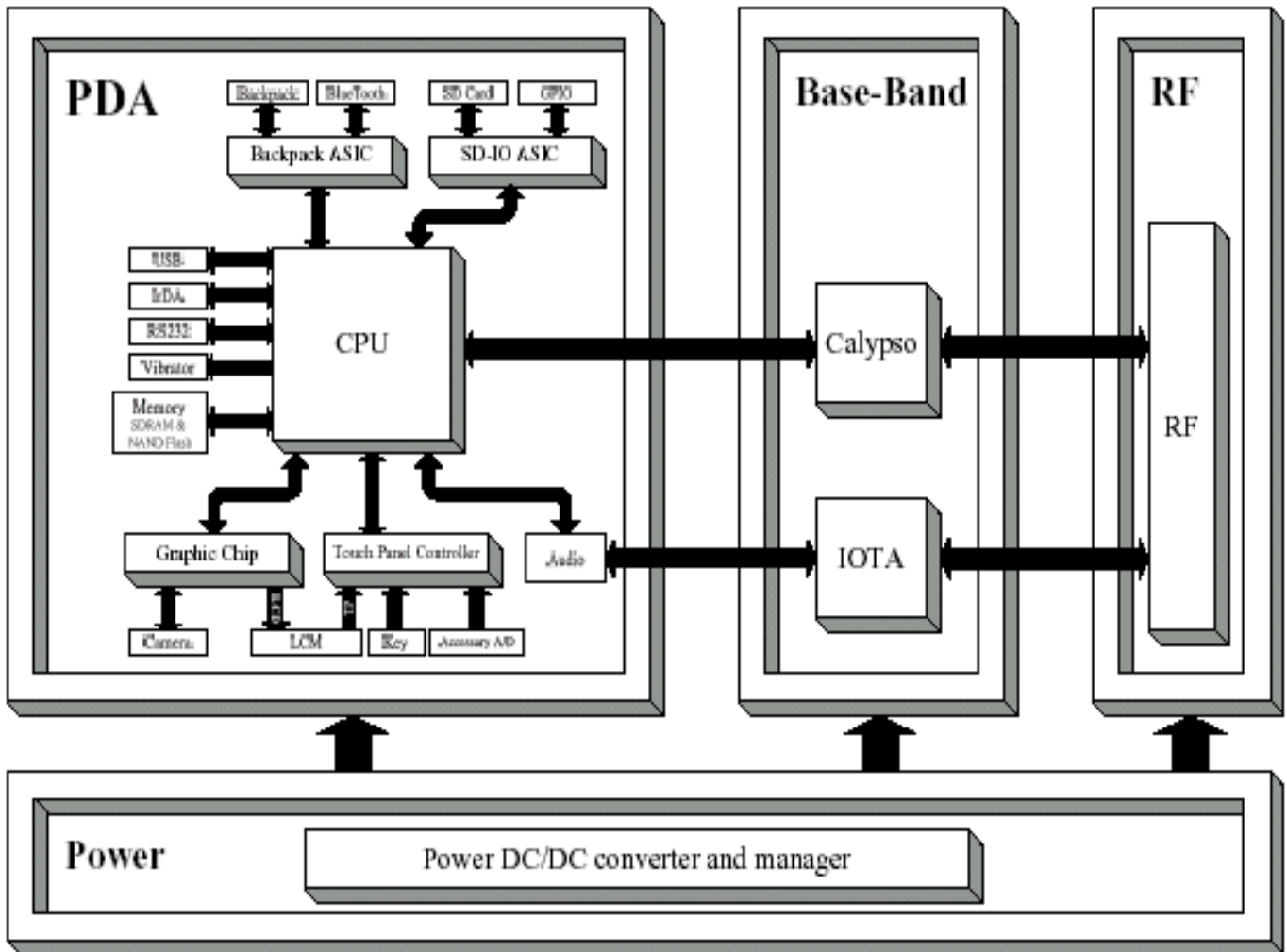

3. Servicing Tools





This chapter provides information for the servicing tools for MDA2.

List of Servicing Tools







No.	Item	Use	Remark
1	USB or Serial Cradle	Check for Cradle I/F (Serial communication only)	
2	USB DATA interface Cable	Check for Cradle I/F (USB communication only)	
3	Special Made Plastic Stick	Disassembling for	
4	SD Memory Card	For SD card test	
5	Earphone Headset	For Audio test.	
6	AC Adapter	Power supply to MDA2.	

5. Assembling and Disassembling

5.1 Disassembling

	<p>Tools needed for Assembling and Disassembling the MDA2</p> <ol style="list-style-type: none"> 1. Lens Cleaning Tissue. 2. Flat Screw Driver 2.4mm 3. Philip Screw Driver #0. 4. Torex Screw Driver T6X40 5. Special Made Plastic Stick. 6. Tweezers.
	<p>Remove the Stylus, SD Card slot Filler, and the Car antenna connector cover.</p>
	<p>Next, Remove the Back cover by releasing the fixing lock as step 1. Then slightly push backward the back cover as step 2.</p>
	<p>Once Back cover is removed, you will find the battery on it.</p>

	<p>Press Unlock and release the battery</p>
	<p>Remove the battery from unit</p> <p> Warning: To reduce risk of fire or burns, do not disassemble, crush, puncture, short external contacts, or dispose of in fire or water. Replace only with specified batteries. Recycle or dispose of used batteries properly.</p> 
	<p>To separate the housing , Use the plastic stick to open the housing . Insert and gently twist into the gap between stylus hole and antenna cover.</p>
	<p>To separate the antenna cover, use the hook of plastic stick to release three hooks of antenna cover.</p>

	<p>There are three hooks which fix the antenna cover and bezel. Insert to the gap and slightly pull upward from right to left to release the hooks.</p>
	<p>Antenna cover is removed. Remove two screws which fix the antenna to MB. Screw P/N:72H00339-00</p> 
	<p>Remove 6 screws which fixed the housing and bezel. There are two types of screw</p>  Screw 1~4 P/N 72H00338-00  Screw 5,6 P/N 72H00339-00
	<p>Now separating the housing. Use plastic stick to slide along the gap (Right side of unit, near stylus hole)</p>



Gently open the housing



Turn over the housing to the other side as shown on picture.

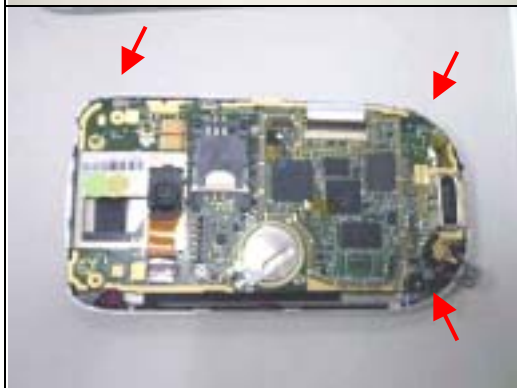

Once the housing is removed, next to remove 3 screws which fix the MB into bezel.



P/N 72H00401-00



Gently and carefully release the LCM FPC by lifting the connector lock upward using your finger or soft plastic tweezers.



Then remove the Camera module by slightly releasing its FPC(1) and camera which is stuck with Double side tap on MB (2)





Turn MB to the other side and remove the Navigation button by pulling up.



Correct position of Navigation button

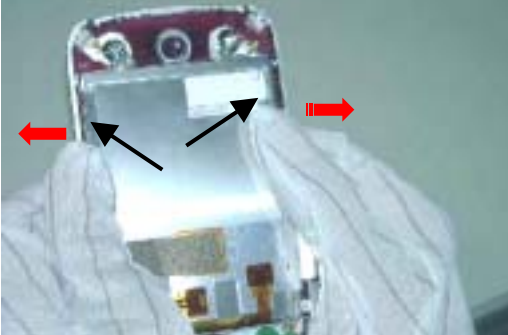

Use tweezers to remove the Vibrator

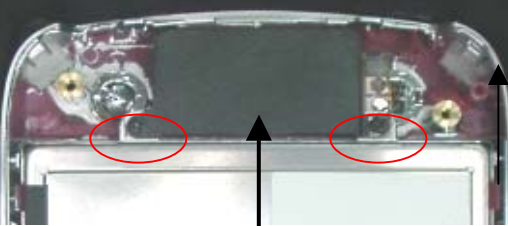
	<p>The LCM, Speaker , MIC is located on upper part (Bezel side).</p>
	<p>To Disassembly LCM module Hold the entire assembly as seen on the picture , push aside the bezel and push the panel from front side simultaneously . Notice the starting location. Doing this to release the LCM from 4 hooks which located 2 at its right and left respectively.</p>
	<p>Then, gently pull out the LCM from its lower part hook .</p>
 <p style="text-align: center;">Speaker</p>	<p>If the Speaker need to be replaced, remove two screw which fix the speaker .</p> <p>P/N: 72H00401-00</p>



If MIC need to be replaced, just take it out from its place slightly by using tweezers.



Take out the MB and disassembly procedure is done.

The disassembly procedure is finished.

5.2 Assembling

	<p>Be noticed that if MB need to be replaced, need to apply insulation tape on lower right corner as shown on picture. Insulation tape P/N: 76H00469-00</p>
	<p>P/N for this insulation tape : 76H00469-00</p>
	<p>On the other side , need to apply 3 gasket on shielding cover. Remember to insert navigation button to its place.</p>
	<p>Next to paste 2 EA Poron (black) aside to SEND and END switch on MB.</p>

	<p>Next to apply one black poron aside to volume button</p> <p>Totally there are four places at MB need to be applied pre-assembly.</p>
	<p>Install the MIC into its place.</p>
	<p>Before Assemble LCM , be noticed to apply stylus poron on the rear side of LCM</p> <p>Be noticed that the poron should not exceed the edge and interfere to bezel hooks.</p>
<p>LCM Poron</p>	<p>Insert the LCM starting from lower bottom part and insert into the rib.</p> <p>Make sure Poron should not exceed the edge to prevent interfere to the bezel's hook and cause gap & stylus stuck after assembly.</p>



Next Push aside the bezel and insert the LCM to click into 2 hooks located on right and left respectively.



Assembly the speaker and fix two screws on it.



Apply 3 screws on MB



Then insert the LCM FPC into the connector , make sure the FPC is fully inserted , then lock it by pressing the cover down.

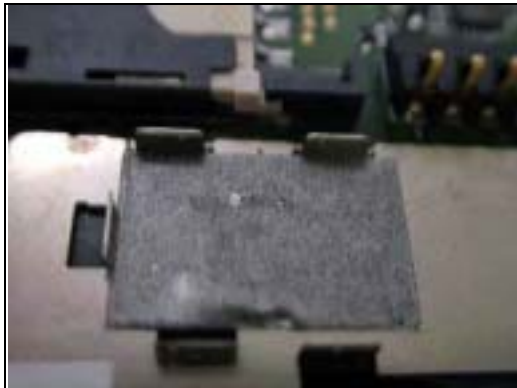

Next Camera module assembly.

1. Make sure the Aluminium foil is clean and workable.
2. Put the Camera on it.



Place the Camera into correct position and fix it.

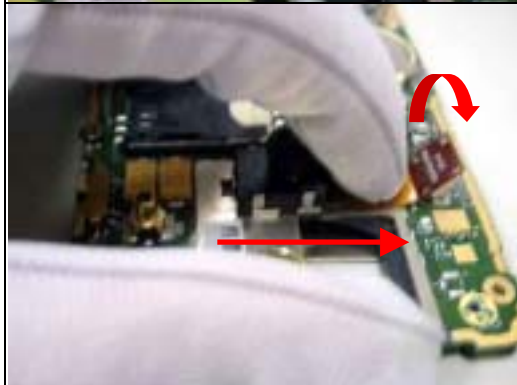

Important Notice:
Before inserting the FPC into its connector, use your finger to flat the FPC first (as shown on picture) the lock it. (The FPC is fragile , to prevent break)



Make sure Camera is fixed correctly.



Next Close the Rear Housing to upper part starting from left side (with Volume button)



TIPS:
Adjust the volume button to its center first before full closing the Housing .







Antenna Assembly
Put the antenna into its place, starting from upper part, then press and insert its two ribs correctly to the housing.



Then fasten two screws of the antenna.

Continuing with 4 screws at the middle part of housing.
P/N:
Next two screws at the lower bottom
P/N:

	<p>FIX Antenna Cover Put the antenna cover and fix it starting from unit left side (side with volume button)</p>
	<p>Warranty Seal (Security Label) Be sure to apply new Warranty seal once the unit has been repaired before sending back to customer.</p>
	<p>In case of MB replacement, since the IMEI has to follow new MB IMEI, repair site is required to re-print Regulatory label to change IMEI no, but Serial No. should remain unchanged.</p>
	<p>Put the Battery into its place and lock it.</p>

	<p>Put back the battery cover.</p>
	<p>Put back the stylus, SD filler and Car antenna connector cover back into the unit.</p>
	<p>Now The unit is ready for performing TEST.</p>

The Unit Assembly is done ready for further tests.

6. Problem Diagnostics

6.1. List of Test Jigs

Item Name	Usage	Remark
RS-232 Serial Cable/Cradle	For data port test	
USB Cable/Cradle	For data port test	
Special Plastic Tool	For unit disassembly	
AC Adapter	For battery recharge and power related tests	
Earphone with Microphone	For audio test	
SD Card or MMC Card	For write protect, read and write test	
SD card with diagnostic	For Function test diagnostic	
Personal Computer (PC)	Use for Communication/Synchronization test	

<Hardware Requirement for PC>

- O.S.: Windows 98/ME/2000
- CPU: Pentium 166MHz or above
- Memory: 64MB~128MB
- PC Link: ActiveSync **3.7**

6.2. Classification of Non-Conformity

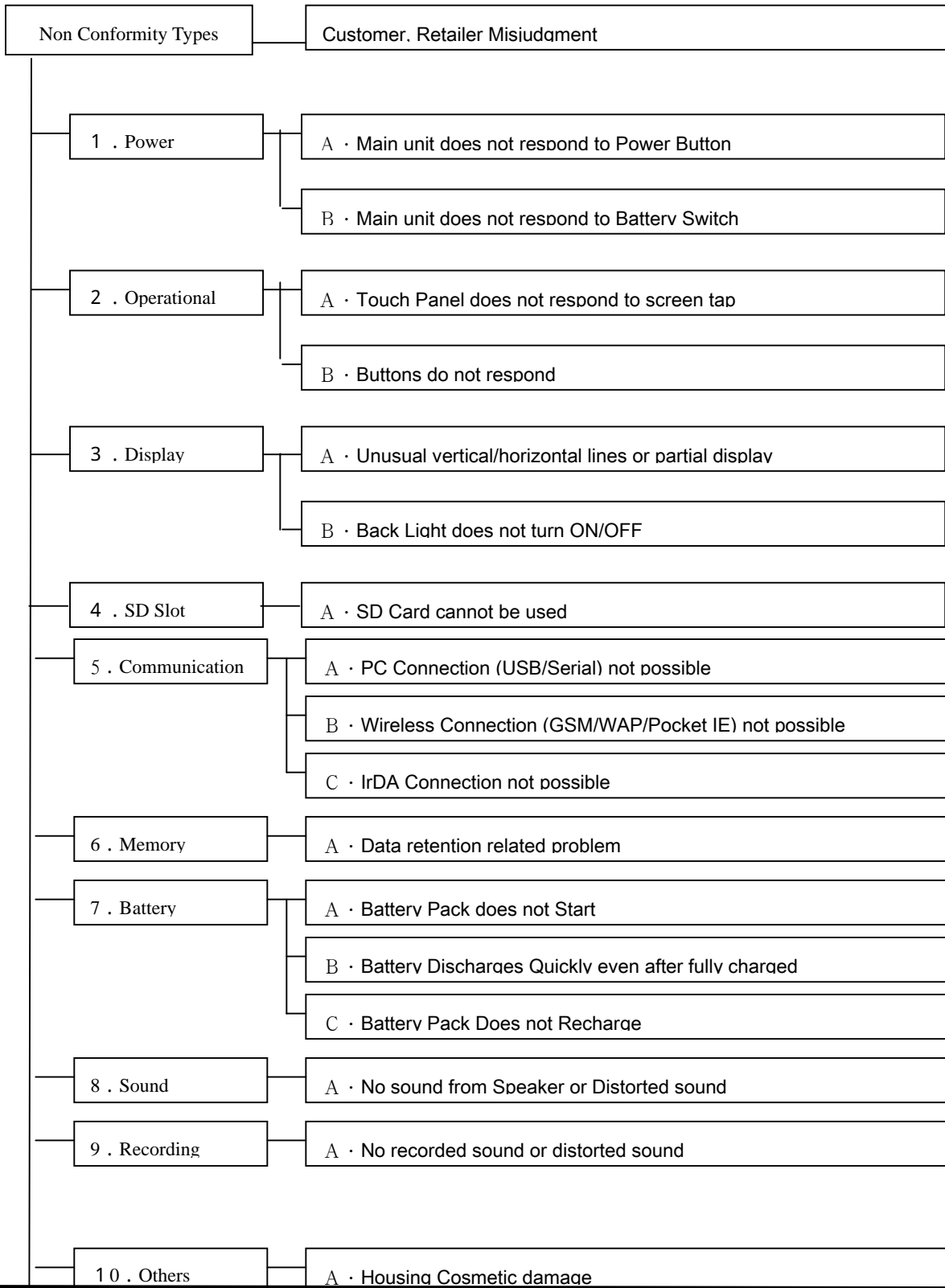

6.3 Troubleshooting & Repair

Before attempting to Diagnose the unit received for repair, perform a Full Reset (Cold Boot) in advance.

1 - A . Main Unit Does Not Respond to Power Button

1 - B . Main Unit Does Not Respond to Battery Switch

- (1) Make sure the Battery is installed properly to activate the battery pack.
- (2) Connect the AC Adapter, maybe the battery pack is exhaust.
- (3) Check the Battery lock is close properly.
- (4) Try with another battery pack.
- (5) Replace battery pack if necessary.
- (6) Check all connections including LCD FPC to Main Board. Try with another Main Board.
- (7) Replace Main Board if necessary.
- (8) Once the defective part has been identified, verify it again with the defective part whether the symptom could be duplicated.

2 - A . Touch Panel Does Not Respond to Screen Tap

- (1) Dismantle the unit, check the perimeter of Display between Front Bezel and Touch Panel surface for unusual foreign objects. Clean it, reassemble the unit and check the panel's function again.
- (2) Check the connection of LCM FPC whether is properly connected.
- (3) Try with another LCM.
- (4) Try with another Main Board.
- (5) Replace LCM if necessary
- (6) Replace Main Board if necessary.
- (7) Once the defective part has been identified, verify it again with the defective part whether the symptom could be duplicated.

2 - B . Buttons Do Not Respond

- (1) Dismantle the unit, check the status of switches on the Main Board and the plastic parts of button of the Button not responding.
- (2) Try with another Main Board or Front Bezel.
- (3) Replace Main Board or Front Bezel if necessary.
- (4) Once the defective part has been identified, verify it again with the defective part whether the symptom could be duplicated.

3 - A . Unusual Vertical / Horizontal lines or partial display

- (1) Check the connection of LCM FPC whether is properly connected.
- (2) Try with another LCM.
- (3) Try with another Main Board.
- (4) Replace LCM if necessary
- (5) Replace Main Board if necessary.
- (6) Once the defective part has been identified, verify it again with the defective part whether the symptom could be duplicated.

3 - B . Back Light Does Not Turn ON/OFF

- (1) Check the connection of FPC whether is properly connected.
- (2) Try with another LCM.
- (3) Try with another Main Board.
- (4) Replace LCM if necessary
- (5) Replace Main Board if necessary.
- (6) Once the defective part has been identified, verify it again with the defective part whether the symptom could be duplicated.

4 - A . SD Card cannot be used

- (1) Check whether SD or MMC Card is fully inserted to the slot until you hear a click.
- (2) Try with another SD / MMC Card and Check whether it is Write Protected.

- (3) Try with another Main Board.
- (4) Replace Main Board if necessary.
- (5) Once the defective part has been identified, verify it again with the defective part whether the symptom could be duplicated.

5 - A . PC Connection (USB / Serial) not possible

- (1) Check whether "Connection Settings" in the MS ActiveSync is properly set.
- (2) Check whether it connects with other cables or cradle, customer's cable might be damaged.
- (3) Check the external appearance of the connector on the unit whether it is physically damaged.
- (4) Replace Main Board if necessary.
- (5) Once the defective part has been identified, verify it again with the defective part whether the symptom could be duplicated.

5 - B . Wireless Connection (GSM / WAP / GPRS) not possible

- (1) Make sure the user has been contacting the Carrier for SIM Card validation and activation.
- (2) Make sure the Wireless Connection Settings has been properly set.
- (3) Make sure the SIM Card is properly inserted to the SIM compartment. Make a life call or test it with the RF Test Station (Antenna Test).
- (4) Dismantle the Main Unit and check whether the Antenna is properly installed.
- (5) Try with another Antenna.
- (6) Try with another Main Board if necessary.
- (7) Once the defective part has been identified, verify it again with the defective part whether the symptom could be duplicated.

5 - C . IrDA Connection not possible

- (1) Make sure the IrDA port settings on the Notebook or PC are properly set.
- (2) Make sure the IrDA function is properly activated on the Pocket PC and on the other device.
- (3) Make sure there's no obstruction between the two devices in connection and within the distance.
- (4) Check the IrDA window whether it is broken or cracked. Replace Front Bezel if necessary.
- (5) Replace Main Board if necessary.
- (6) Once the defective part has been identified, verify it again with the defective part whether the symptom could be duplicated.

6 - A . Data Retention related problem

- (1) Back up battery is rechargeable, to retention purpose when main battery power is used up or when changing the main battery, Make sure to charge the unit if not use for a while.
- (2) Data introduced by User might be lost when Battery has drained completely.
- (3) Ask user to charge the Main Unit when latest warning message pops up.
- (4) Ask users to back up their data to the PC or SD card when expect stop using the unit for long period of time, for example, more than one week.
- (5) Charge the Main Unit and check if data loses even the Battery pack is charged or at least The unit still can be powered on without AC Adapter.
- (6) Check whether AC Adapter is functioning properly.
- (7) Check whether the condition of Battery Charging status is correct.
- (8) Check the appearance of Battery Pack.
- (9) Replace Battery Pack if necessary
- (10) Replace Main Board if necessary.
- (11) Once the defective part has been identified, verify it again with the defective part whether the symptom could be duplicated.

7 - A . Battery Pack does not start

- (1) Make sure the Battery lock is closed properly. Data introduced by User might be lost when Battery has drained completely.
- (2) Connect to the AC Adapter and see if it takes charge. Also check AC Adapter condition.
- (3) Ask users to back up their data to the PC or SD card when expect stop using the unit for long period of time, for example, more than one week.
- (4) Charge the Main Unit and check if data loses even the Battery pack is charged or at least The unit still can be powered on without AC Adapter.
- (5) Check whether AC Adapter is functioning properly.
- (6) Check whether the condition of Battery Charging status is correct.
- (7) Dismantle the unit and check the appearance of Battery Pack.
- (8) Try with another Battery Pack or Replace Battery Pack if necessary
- (9) Try with another Main Board or Replace Main Board if necessary.
- (10) Once the defective part has been identified, verify it again with the defective part whether the

symptom could be duplicated.

7 - B . Battery discharges quickly even after fully charged

- (1) Make sure the Battery Pack takes fully charge with AC Adapter.
- (2) Check whether the condition of Battery Charging status is correct.
- (3) Dismantle the unit and check the appearance of Battery Pack.
- (4) Try with another Battery Pack or Replace Battery Pack if necessary
- (5) Try with another Main Board or Replace Main Board if necessary.
- (6) Once the defective part has been identified, verify it again with the defective part whether the symptom could be duplicated.

7 - C . Battery Pack does not recharge

- (1) Make sure the Battery Pack takes fully charge with AC Adapter.
- (2) Check whether the condition of Battery Charging status is correct. Charge should be done in no more than 3 hours.
- (3) Dismantle the unit and check the appearance of Battery Pack.
- (4) Try with another Battery Pack or Replace Battery Pack if necessary
- (5) Try with another Main Board or Replace Main Board if necessary.
- (6) Once the defective part has been identified, verify it again with the defective part whether the symptom could be duplicated.

8 - A . No Sound from Speaker or Distorted sound

- (1) Check "Sound & Notifications" Settings in the unit for Sound Enabling.
- (2) Make sure it's not MUTED.
- (3) Dismantle and Check whether the Speaker is properly installed (Orientation)
- (4) Replace Speaker if necessary.
- (5) Replace Main Board if necessary.
- (6) Once the defective part has been identified, verify it again with the defective part whether the symptom could be duplicated.

9 - A . No Recorded Sound or Distorted sound

- (1) Check "Sound & Notifications" Settings in the unit for Sound Enabling.
- (2) Make sure it's not MUTED.
- (3) Dismantle and Check whether the Microphone is properly installed (check or missing rubber)
- (4) Replace Microphone if necessary.
- (5) Replace Main Board if necessary.
- (6) Once the defective part has been identified, verify it again with the defective part whether the symptom could be duplicated.

10 - A . Housing Cosmetic damage

- (1) Unless it is for Refurbishment, all housing replacement due to cosmetic damage shall be subject to be charged.

7. Diagnostic Program

7.1. List of Test Items

No.	Item	Description	Remark
1	RAM Test	RAM Check Size/Write/Read/Comparison test.	
2	Display Test	Test the LCD display quality.	
3	Touch Test	Touch screen alignment test. Suggest to test in WinCE	
4	Playback Test	Play sound with 8KHz simulation wave.	
5	Record Test	Record audio sound and playback it(INT/EXT)	
6	Button Test	Test every most of button.	
7	Checksum Test	To show checksum value after Code reflash	
8	B Light Test	Back light ON with in different brightness level.	
9	LED Test	Test the message LED.	
10	Battery Test	Check the status of battery and AC power.	
11	Vibrater Test	Test the function of the vibrater.	
12	SD Test	SD card Write/Read/Write Protect test.	
13	Clean Talk Time	Clean Talk time(Air time) & Format PIM storage CAUTION: This item is applied for refurbishment case only. For same unit repair back to customer is not necessary.	
14	USB Test	Suggest to test in Windows CE	
15	Sir Test	Suggest to test in Windows CE	
16	Serial Test	Suggest to test in Windows CE	

7.2 Test Items Operation

Power on the unit. While press and hold the **Power** Button, **Action** button and **Reset** the unit with the Stylus, release RESET button first about 1 second the to enter the **Test Mode**. You will find the display as following:

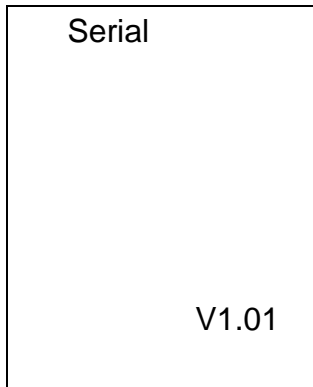

Then, wait about 10 seconds, the display will show :

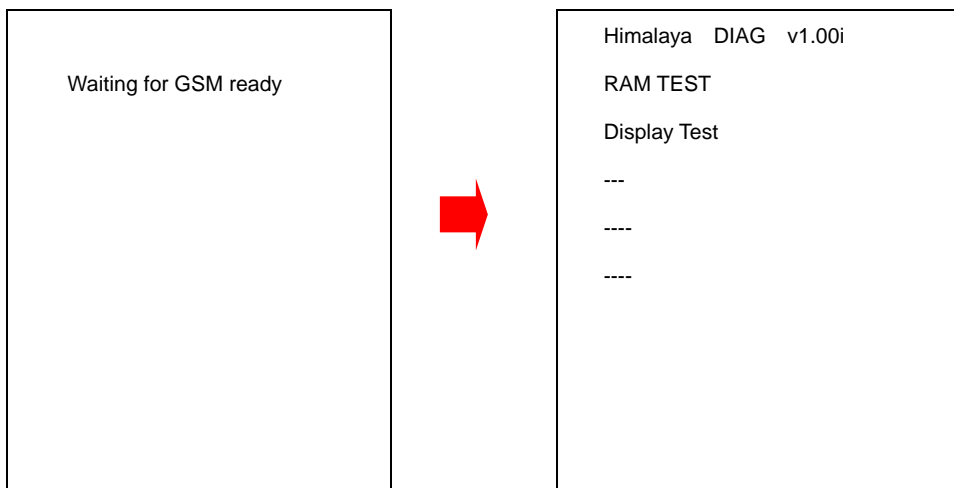

How to select test item: Using navigation button - "**Up**" or "**Down**" to select the test items

How to execute the test program: Press "**Action**" to start the test

No.	Item	Description	Possible cause if fail
1	RAM Test	Display Size and read/write test. It will show OK if pass. Stop on fail.	Could be M/B issue
2	Disp Test	Unit prompts for different display page to detect the defect of LCD, lines or dots. First display is WHITE screen, Press left to DARK screen Press UP to Multiple Color Press RIGHT for back to MENU	Could be LCD issue

3	Touch Test	Tap the cross mark (+) with stylus on the correct location. Fail if no reaction Calibrate the screen following the + mark. Press ACTION to exit.	Could be LCM issue
4	Play Test	Play the tone with 8KHz/L-channel, then Hear the sound and notice if bad sound quality happens	Could be speaker or M/B issue
5	Record Test	Select this item to record test, then press Action to start recording. It will automatically playback it. Then connect with earphone or external speaker and press action to check the record function is OK or not thru ext speaker.	Could be MIC or M/B issue
6	Button Test	Press each button to know if it works. Follow the instruction shown on the screen to finish the test item Stop on fail.	Could be switch or MB issue
7	Checksum	Verifies the checksum of the code.	
8	B Light Test	Back Light turns ON and Off, Check the light change Starting from Level 3 Press Action button to enter Level 2 Press Action button again to enter Level 1 Press Action again to enter Level 0 Action again for back to MENU	Could be M/B or LCM issue
9	LED Test	The message LED will show starting with RED Press Action LED will change to GREEN Press Action LED will change to AMBER Press Action Key LED will ON (YES & END) Press again Action will back to MENU	Could be LED or M/B issue
10	Battery Test	Test main battery and AC power source. Insert AC power CUR will show "+ " means charging , remove AC power CUR will show "-" means internal power. Note: The Battery capacity shown is only for reference	Could be main battery or M/B
11	Vibrator Test	Press action, units should vibrate. Press Action again back to MENU	Check the vibrator

12	SD Test	<p>Insert SD card (Enable Write Protect) and start test. Pull out the SD card if you see the message< "Pluck OK ><Locked > Please remove locked SD . Adjust lock switch to unlock site (Disable Write Protect), and insert it. The program will read & write to SD card for test. Once finished, display will show Please remove SD card.</p> <p>Press Action back to MENU</p>	Could be M/B issue
13	Clean Talk Time	Select this item to clean AIR TIME (Talk time) and Customer PIM data.	Use this item only for REFURBISHMENT CASE
14	USB Test	Plug USB cable to connect PDA to PC then and check for the connection in WinCE.	Could be M/B issue
15	SIR Test	<p>Prepare another unit as 'supporting' site. On test unit, please choose 'Test Target' and press action button to start test.</p> <p>Before test, make the IR ports of them face to each other.</p>	<p>Could be M/B issue</p> <p>Suggest to test it in Windows CE mode.</p>
16	Serial Port Test	Check this item in Windows CE mode.	Could be M/B issue

8.1 Exploded Diagrams & Spare part list

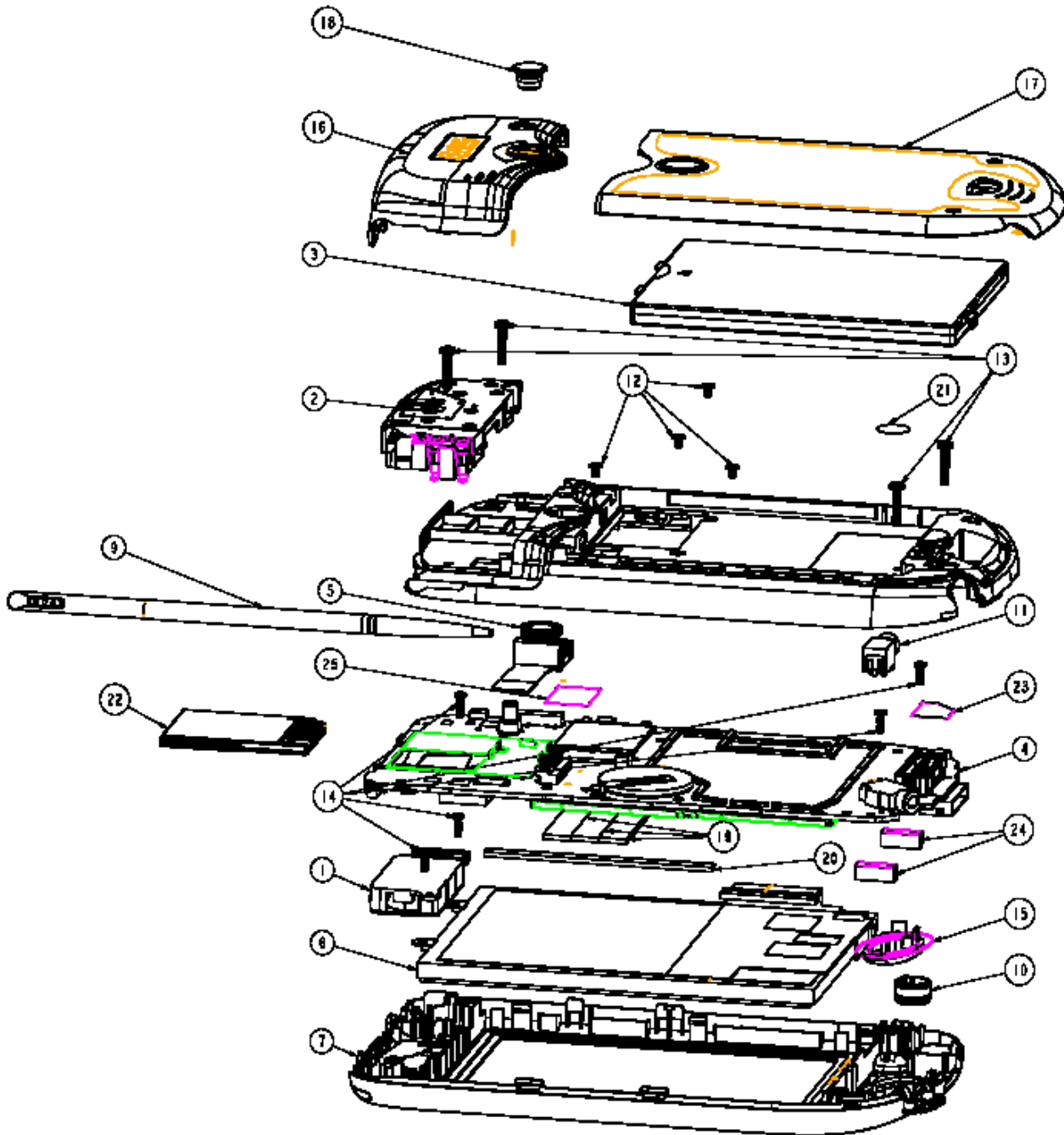

Spare part list

Item	Description	HTC P/N	Using Q'ty
1	Speaker, MDA2	36H00177-00	1
2	GSM ANTENNA	36H00158-00	1
3	RECHARGEABLE BATTERY,LI-ION polymer,3.7V,1200m	35H00020-01	1
4	FRU, Main Board, GER, Phone, T-Mobile, 128 MB (Different Country has different P/N)	99HY0020-00	1
5	CMOS Camera Module	54H00063-00	1
6	LCM, ACX502AKN,SONY	60H00011-00	1
7	BEZEL, PRE-ASSY T-MOBILE,HIMALAYAS	74H00170-01	1
8	HOUSING, PRE-ASSY, HIMALAYAS	74H00171-00	1
9	STYLUS, HIMALAYAS	74H00187-00	1
10	MICROPHONE ASSY,MD6022ARC-9,W/RUBBER BOOT,EMKA	36H00132-00	1
11	Vibrator,Cylinder type,A4A-05-WTB-3,C.I.Kasei,	36H00180-00	1
12	SCREW,PH,FLAT,M1.4X2.5,NYLOK,L1.5	72H00338-00	4
13	SCREW,TOREX, M1.6x8,NYLOK,L4.5	72H00339-00	4
14	SCREW,PH,FLAT,1.4X4,PT,BLACK	72H00401-00	5
15	JOYPAD,PRE-ASSY,HIMALAYAS	74H00202-00	1
16	COVER,ANTENNA,PRE-ASSY,HIMALAYAS	74H00218-00	1
17	COVER,BATTERY,PRE-ASSY,HIMALAYAS	74H00219-00	1
18	RUBBER-COVER,ANTENNA-CONN,HIMALAYAS	76H00398-00	1
19	CONDUCTIVE-FABRIC,PCB,HIMALAYAS	72H00411-00	3
20	PORON,STYLUS,HIMALAYAS	76H00453-00	1
21	SECURITY LABEL,HIMALAYAS (WARRANTY SEAL)	77H00083-00	1
22	DUMMY, SD, CARD, HIMALAYAS	71H00651-00	1
23	INSULATOR,TAPE,PCB,HIMALAYAS	76H00469-00	1
24	PORON , PCB ,	76H00473-00	2
25	ALUMINUM-FOIL,CAMERA,HIMALAYAS ,stick on MB	72H00412-00	1

Besides of shown on exploded diagram, there are some more parts as following:

1	Conductive fabric, use on camera	72H00410-00	1
2	Insulation-tape, use on camera	76H00471-00	1
	Please Refer Spare Part List from our Logistic for complete one .		

Appendix

A. Customer, Retailer Misjudgment

Before attempt repairing the unit, make sure the type of reported failure could be clearly reproduced; otherwise, check with the customer or distributor once again to identify the problem correctly.

The following are failure symptoms that are typical by misjudgment

No.	Item	Possibility
1	No Power even the power button is pressed	Built-in Battery switch is switched OFF or exhausted.
		While Back Light is turned OFF, the surrounding lighting will be reflected on the panel and in a dim location, it looks like the unit is turned OFF.
		According to the Power Management settings, the units will be switched OFF automatically.
2	Battery discharges quickly	The battery life depends on the devices being used in SD Card Slot, and frequency of use of the Front light. These functions consume a lot of energy.
		Operating with front light ON, or using high energy consumption devices such as SD Memory Card will drain out the battery pack faster.

3	Battery cannot be charged	Using AC adapter that is NOT supplied with the unit.
		<p>Charging the battery while operating the unit with heavy loadings could cause the temperature inside the unit to build up which could cause the unit stop charging. At this moment, the LED indicator will flash Yellow to notify user that the charging has been stopped. Or the temperature is extremely low will also stop charging.</p> <p>Since the extreme high or low temperature will cause the battery to discharge quickly, it has been designed to cut battery charge below 0 and above 35~40 to protect the battery pack.</p>
4	Cannot make communications via mobile phones through exclusive cable.	If the unit could pass the test with Loop back Interface card, the possibility of unit malfunction becomes low. Then the following items could be the reason of problem such as location, timing, signal strength, service provider's mixed up, or problem with the mobile itself. Or could be incompatibility issue.
5	Cannot use SD/CF Memory Card	Cards which are not being pre-formatted.
		SD card has been switched to Write Protect mode.
		Card not inserted completely, or bad contact between connector contacts.
6	Black or White dot on the screen.	For LCD panel's normal behavior, it is hard to find a panel without any bad pixel. Once the numbers of dots and the distance between them are within the specifications, it is allowed.
7	Touch Screen or Program Buttons are not reacting.	Could be wrong operation.
		Screen not properly aligned with the stylus calibration.
8	Front Light dim, cannot turn ON, or shuts OFF automatically.	Check the Front Light settings in Power Management settings
9	Cannot playback music, No sound or volume is low.	When Battery low, the music playback becomes difficult and the volume could become lower.
10	Cannot execute installed application programs	Could be an incompatible software
11	Operation is slow in response	Could be insufficient memory. Check amount of system memory.

12	Hang up	Software being used sometimes is not fully compatible with the system.
		Execute many application programs simultaneously
		Software that requires big amount of memory spaces or the system memory is low or the files being used is fragmented.
13	System Memory is enough, but is shows insufficient.	Software that requires big amount of memory spaces or the system memory is low or the files being used is fragmented.

****Note: Nevertheless, the above symptoms could be solved by a warm boot or cold boot, make sure the warm/cold boot has been executed and try to reproduce the symptom reported.***

How to perform Warm Boot and Cold Boot :

Warm Boot : Reset the unit by pressing reset button.

Cold Boot : Press Power button and Reset the unit simultaneously.

B. Repair Troubleshooting Guide

